



INSTRUCTION MANUAL

SIL 2 Switch/Proximity Detector Repeater
Transistor Open Collector Output, DIN-Rail and
Termination Board, Models D6031S, D6031D



General Description:

The single and dual channel Switch/Proximity Detector Repeater, D6031S and D6031D module is a unit suitable for applications requiring SIL 2 level (according to IEC 61508:2010 Ed. 2) in safety related systems for high risk industries. The unit can be configured for switch or proximity detector (EN60947-5-6, NAMUR), NO or NC and for NO or NC optocoupled open collector transistor output. Each channel enables a load to be controlled by a switch, or a proximity detector.

Fault detection circuit (DIP switch configurable) is available for both proximity sensor and switch equipped with end of line resistors. In case of fault, when enabled it de-energizes the corresponding output transistor and turns the fault LED on; when disabled the corresponding output transistor repeats the input line open or closed status as configured.

D6031D is programmable via dip switches as single input and two independent outputs. Out 2 can be programmed for output duplicating Out 1 or fault detection Out.

In case of duplication, transistor driving can be independently configured for each output. In case of fault output, transistor driving can be programmed as normally closed (NC) or normally open (NO).

Mounting on standard DIN-Rail, with or without Power Bus, or on customized Termination Boards, in Safe Area.

Functional Safety Management Certification:

G.M. International is certified by TUV to conform to IEC61508:2010 part 1 clauses 5-6 for safety related systems up to and included SIL3.



Technical Data

Supply:

24 Vdc nom (18 to 30 Vdc) reverse polarity protected, ripple within voltage limits ≤ 5 Vpp, 2 A time lag fuse internally protected.

Current consumption @ 24 V: 22 mA for 2 channels D6031D, 12 mA for 1 channel D6031S with short circuit input and transistor closed, typical.

Power dissipation: 0.53 W for 2 channels D6031D, 0.30 W for 1 channel D6031S with 24 V supply voltage, short circuit input and transistor closed, typical.

Isolation (Test Voltage):

I.S. In/Out 2.5 KV; I.S. In/Supply 2.5 KV; I.S. In/ I.S In 500 V;

Out/Supply 500 V; Out /Out 500 V.

Input switching current levels:

ON ≥ 2.1 mA (1.9 to 6.2 mA range), OFF ≤ 1.2 mA (0.4 to 1.3 mA range),

switch current ≈ 1.65 mA \pm 0.2 mA hysteresis.

Fault current levels: open fault ≤ 0.2 mA, short fault ≥ 6.8 mA

(when enabled both faults de-energize channel transistor with single channel unit D6031S or de-energize channel transistor with D6031D used as dual channel unit or actuate the fault transistor out with D6031D used as fault signaling unit).

Input equivalent source: 8 V 1 K Ω typical (8 V no load, 8 mA short circuit).

Output:

voltage free SPST optocoupled open-collector transistor.

Open-collector rating: 100 mA at 35 Vdc (≤ 1.5 V voltage drop).

Leakage current: ≤ 50 μ A at 35 Vdc.

Response time: ≤ 100 μ s.

Frequency response: 5 KHz maximum.

Compatibility:

CE mark compliant, conforms to Directives:

2004/108/CE EMC, 2006/95/EC LVD, 2011/65/EU RoHS.

Environmental conditions:

Operating: temperature limits -40 to $+70$ °C, relative humidity 95 %, up to 55 °C.

Storage: temperature limits -45 to $+80$ °C.

Approvals:



TUV Certificate conforms to IEC61508:2010 Ed. 2 (Pending).

TÜV Certificate No. C-IS-236198-09, SIL 3 Functional Safety Certificate conforms to IEC61508:2010 Ed.2, for Management of Functional Safety.

Mounting:

T35 DIN-Rail according to EN50022, with or without Power Bus or on customized Termination Board.

Weight: about 130 g D6011D, 110 g D6011S.

Connection: by polarized plug-in disconnect screw terminal blocks to accommodate terminations up to 2.5 mm².

Protection class: IP 20.

Dimensions: Width 12.5 mm, Depth 123 mm, Height 120 mm.

Ordering Information

Model:	D6031	
1 channel		S
2 channels		D

Power Bus and DIN-Rail accessories:
 Connector JDFT049 Cover and fix MCHP196
 Terminal block male MOR017 Terminal block female MOR022

Front Panel and Features

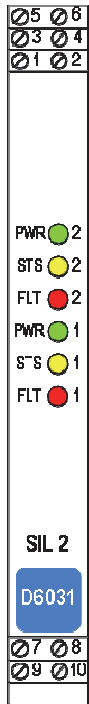

- SIL 2 according to IEC 61508:2010 Ed. 2
- 2 fully independent channels.
- Input from Zone 0 (Zone 20) / Division 1, installation in Zone 2 / Division 2.
- NO/NC switch/proximity Detector Input, NO/NC transistor driving mode.
- Field open and short circuit detection.
- Three port isolation, Input/Output/Supply.
- EMC Compatibility to EN61000-6-2, EN61000-6-4, EN61326-1, EN61326-3-1 for safety system.
- In-field programmability by DIP Switch.
- TÜV Functional Safety Certification.
- High Density, two channels per unit.
- Simplified installation using standard DIN-Rail and plug-in terminal blocks, with or without Power Bus, or customized Termination Boards.

Terminal block connections

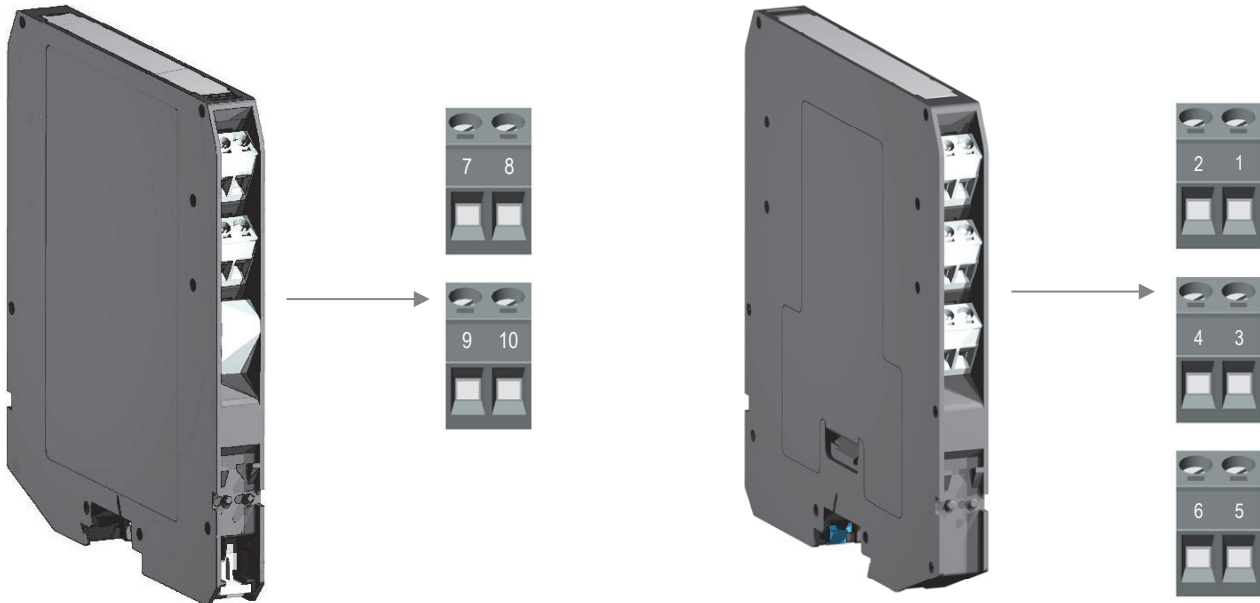

7 + Input Ch 1 for Proximity or Voltage free Contact

8 - Input Ch 1 for Proximity or Voltage free Contact

9 + Input Ch 2 for Proximity or Voltage free Contact

10 - Input Ch 2 for Proximity or Voltage free Contact

1 + Output Ch 1

2 - Output Ch 1

3 + Output Ch 2

4 - Output Ch 2

5 + Power Supply 24 Vdc

6 - Power Supply 24 Vdc

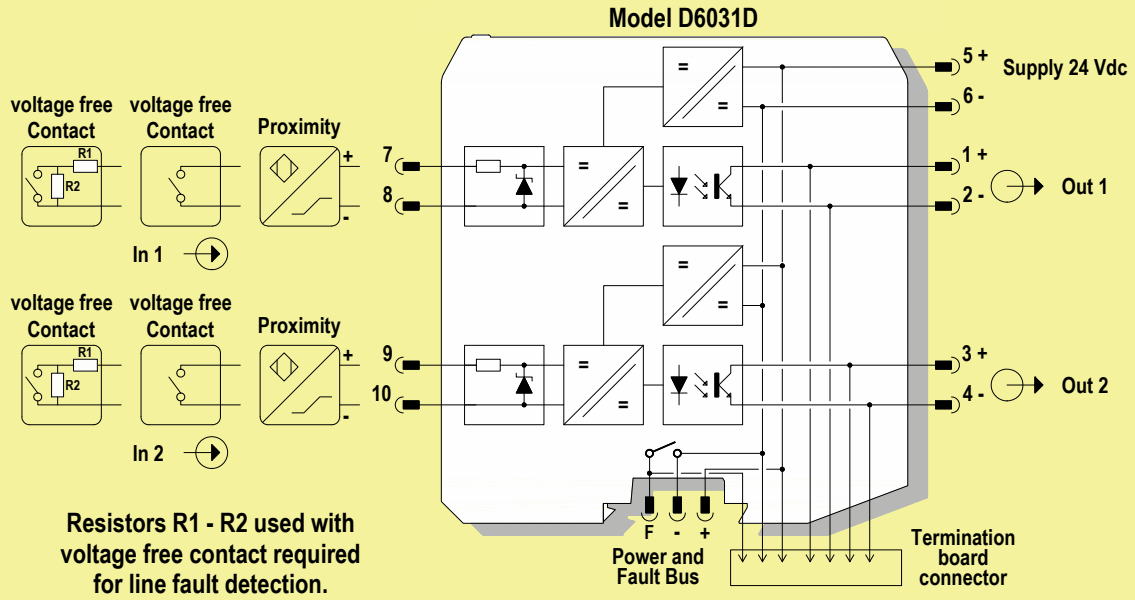

Terminals 9-10 must be shorted to set module as Duplicator or Fault Out

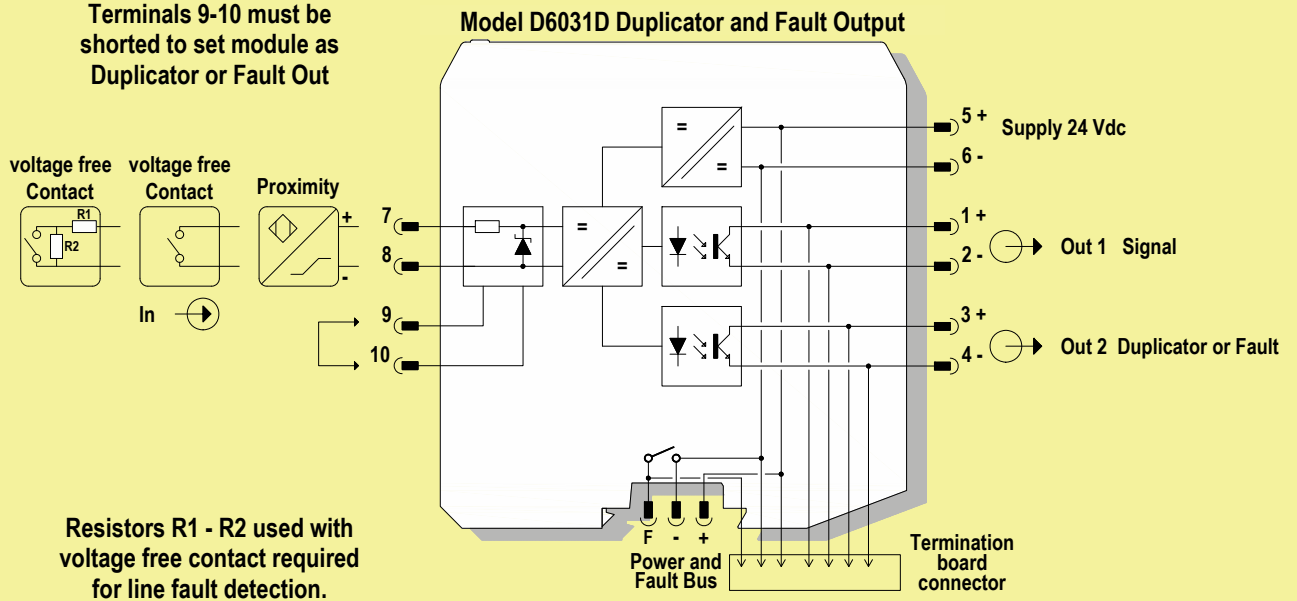

Internal Dip switches programmable

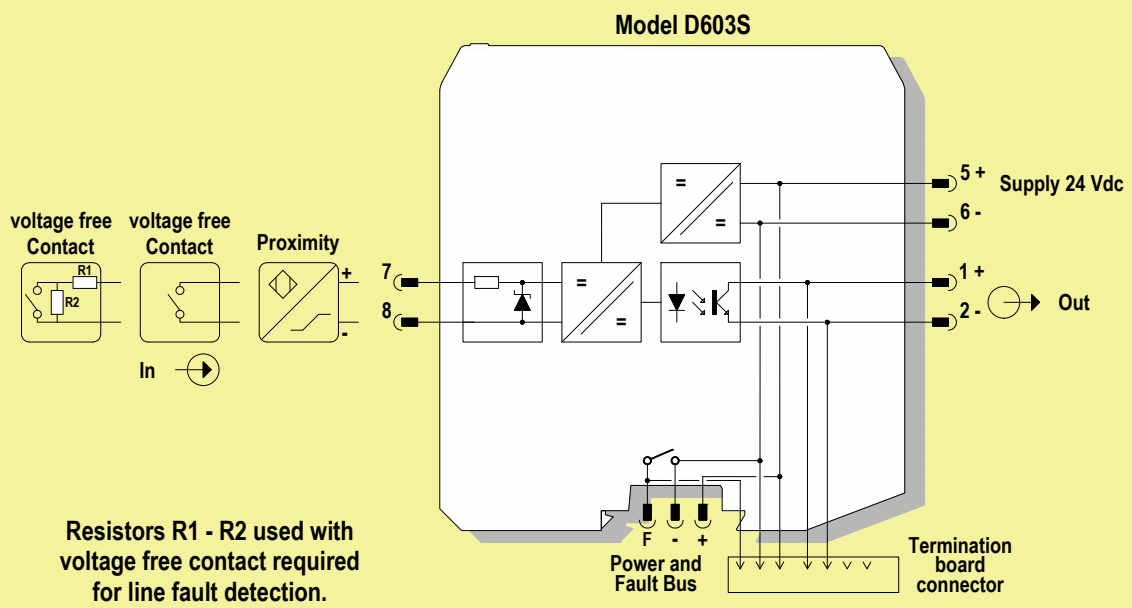

Warning

D6031 series must be installed, operated and maintained only by qualified personnel, in accordance to the relevant national/international installation standards. Failure to properly installation or use of the equipment may risk to damage the unit or severe personal injury. The unit cannot be repaired by the end user and must be returned to the manufacturer or his authorized representative. Any unauthorized modification must be avoided.

Operation

D6031 module is a unit suitable for applications requiring SIL 2 level (according to IEC 61508) in safety related systems for high risk industries. The unit can be configured for switch or proximity detector (EN60947-5-6, NAMUR), NO or NC and for NO or NC optocoupled open collector transistor output. Each channel enables a load to be controlled by a switch, or a proximity detector. Fault detection circuit (DIP switch configurable) is available for both proximity sensor and switch equipped with end of line resistors. In case of fault, when enabled it de-energizes the corresponding output transistor and turns the fault LED on; when disabled the corresponding output transistor repeats the input line open or closed status as configured. D6031D is programmable via dip switches as single input and two independent outputs. Out 2 can be programmed for output duplicating Out 1 or Fault detection Out. In case of duplication, transistor driving can be independently configured for each output. In case of fault output, transistor driving can be programmed as normally close or normally open. Presence of supply power and status of output (energized or de-energized), as well as integrity or fault condition of sensor and connecting line are displayed by signaling LEDs (green for power, yellow for status and red for fault condition).

Note: use of voltage free electrical contacts with fault detection enabled (control equipment) requires, near the switch at the end of the line a $R1=1\text{ k}\Omega$ typical ($470\ \Omega$ to $2\text{ k}\Omega$ range) resistor in series and a $R2=10\text{ k}\Omega$ typical ($5\text{ k}\Omega$ to $15\text{ k}\Omega$ range) resistor in parallel to the contacts in order to allow the fault detection circuit to distinguish between a condition of contact close/open and a line open/short circuit fault.

Installation

D6031 series are Switch/Proximity Detector Interface housed in a plastic enclosure suitable for installation on T35 DIN-Rail according to EN50022, with or without Power Bus or on customized Termination Board. D6031 unit can be mounted with any orientation over the entire ambient temperature range. Electrical connection of conductors up to 2.5 mm^2 are accommodated by polarized plug-in removable screw terminal blocks which can be plugged in/out into a powered unit without suffering or causing any damage. The wiring cables have to be proportionate in base to the current and the length of the cable. On the section "Function Diagram" and enclosure side a block diagram identifies all connections. Identify the number of channels of the specific card (e.g. D6031S is a single channel model and D6031D is a dual channel model), the function and location of each connection terminal using the wiring diagram on the corresponding section, as an example:
Connect 24 Vdc power supply positive at terminal "5" and negative at terminal "6".
For Model D6031S connect positive output of channel 1 at terminal "1" and negative output at "2".
For Model D6031D in addition to channel 1 connections above, connect positive output of channel 2 at terminal "3" and negative output at "4".
For Model D6031S, in case of Proximity or Voltage free Contact, connect the wires at terminal "7" for positive and "8" for negative.
For Model D6031D in addition to channel 1 connections above, connect terminal "9" for positive and "10" for negative on channel 2.

Connect SPST output transistors checking the load rating to be within the maximum rating (100 mA at 35 Vdc ($\leq 1.5\text{ V}$ voltage drop)). Units must be protected against dirt, dust, extreme mechanical (e.g. vibration, impact and shock) and thermal stress, and casual contacts. If enclosure needs to be cleaned use only a cloth lightly moistened by a mixture of detergent in water. Any penetration of cleaning liquid must be avoided to prevent damage to the unit. Any unauthorized card modification must be avoided. According to EN61010, D6031 series must be connected to SELV or SELV-E supplies.

Start-up

Before powering the unit check that all wires are properly connected, particularly supply conductors and their polarity, input and output wires. Check conductors for exposed wires that could touch each other causing dangerous unwanted shorts. Turn on power, the "power on" green led must be lit, status and fault led on each channel must be in accordance with condition of the corresponding input line. If possible close and open input lines one at time checking the corresponding status and fault leds condition as well as output to be correct.

D6031D used as double channel

A configuration DIP switch is located on component side of pcb. This switch allows the configuration of input/output relationship, fault detection functions and operating mode.

WARNING: dip-switch 6-7-8 must be set to "OFF" position.

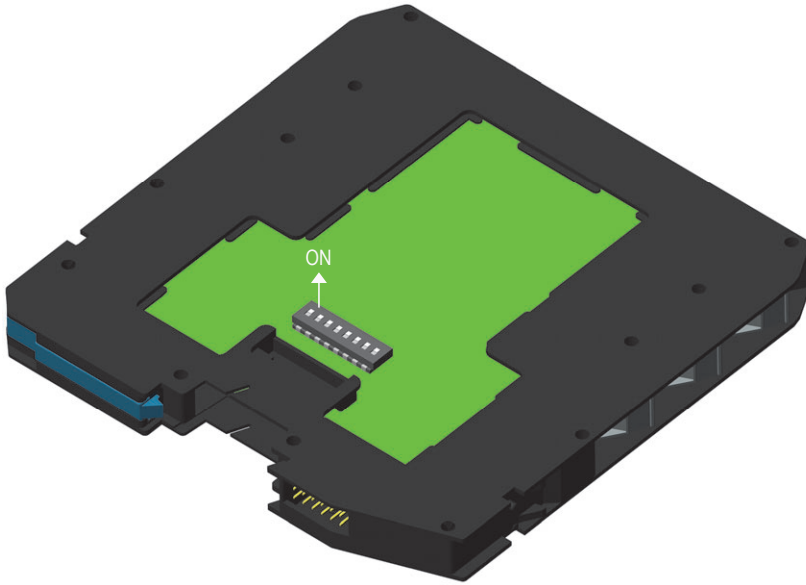

Dip switch factory settings. All Switches are OFF

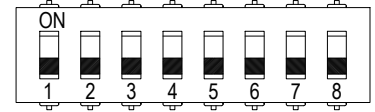

Dip switch configuration

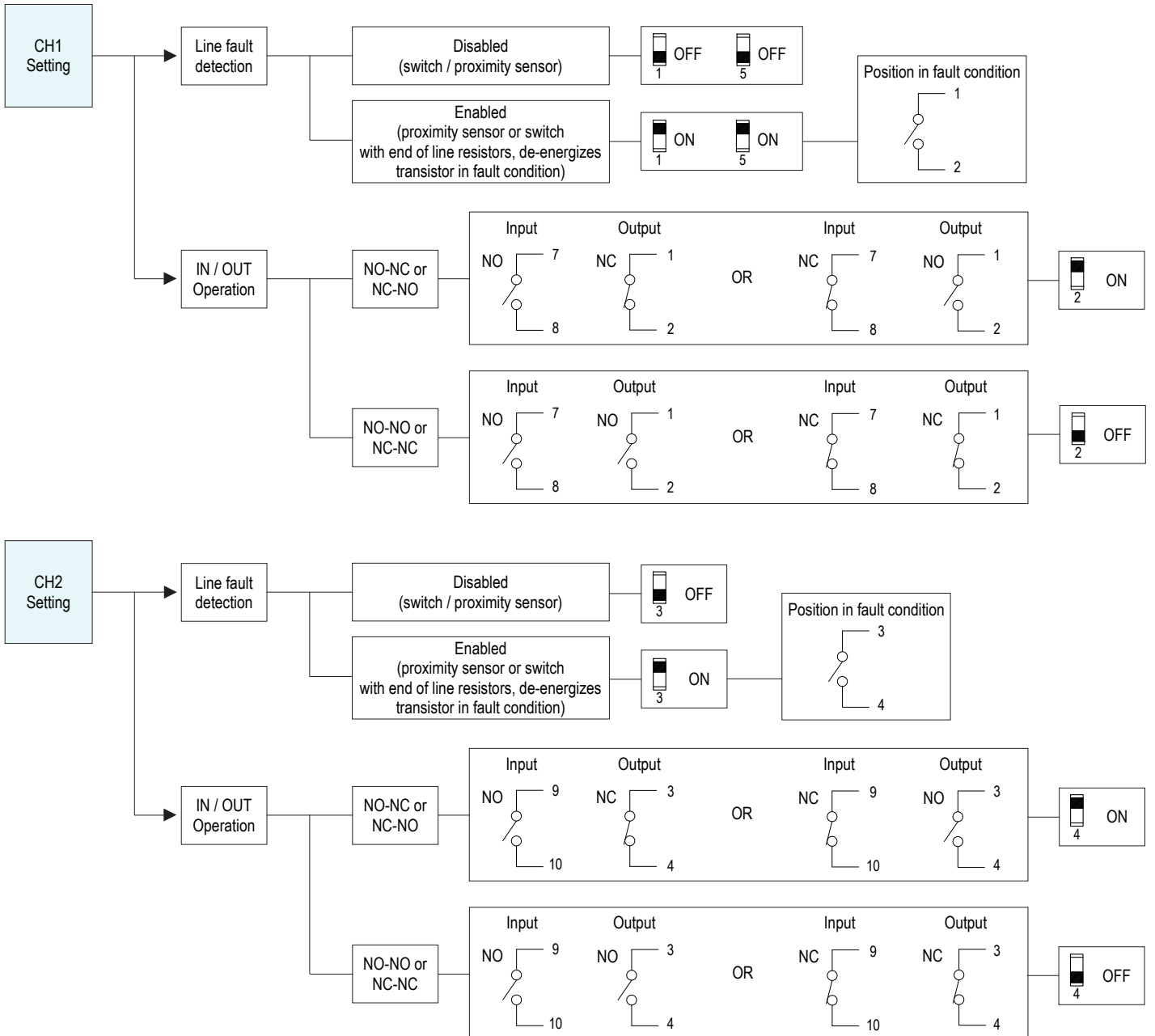
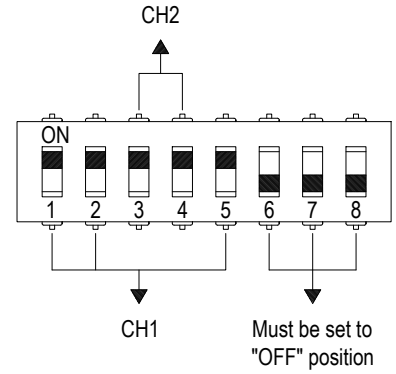

D6031D used as duplicator or fault output

A configuration DIP switch is located on component side of pcb. This switch allows the configuration of input/output relationship, fault detection functions and operating mode.

WARNING: Terminals 9-10 must be shorted to set module as Duplicator or Fault Out.

Dip-switch 3 must be set to "OFF" position.

Dip switch factory settings. All Switches are OFF

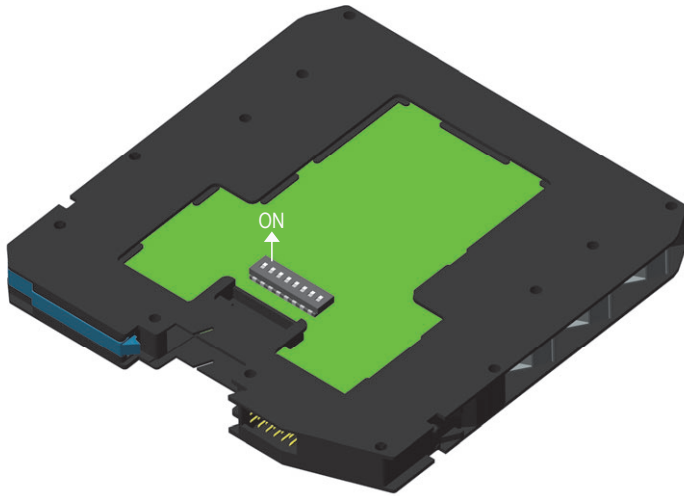
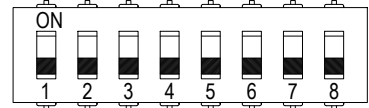

Dip switch configuration

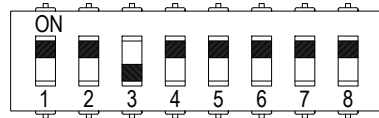

Must be set to "OFF" position

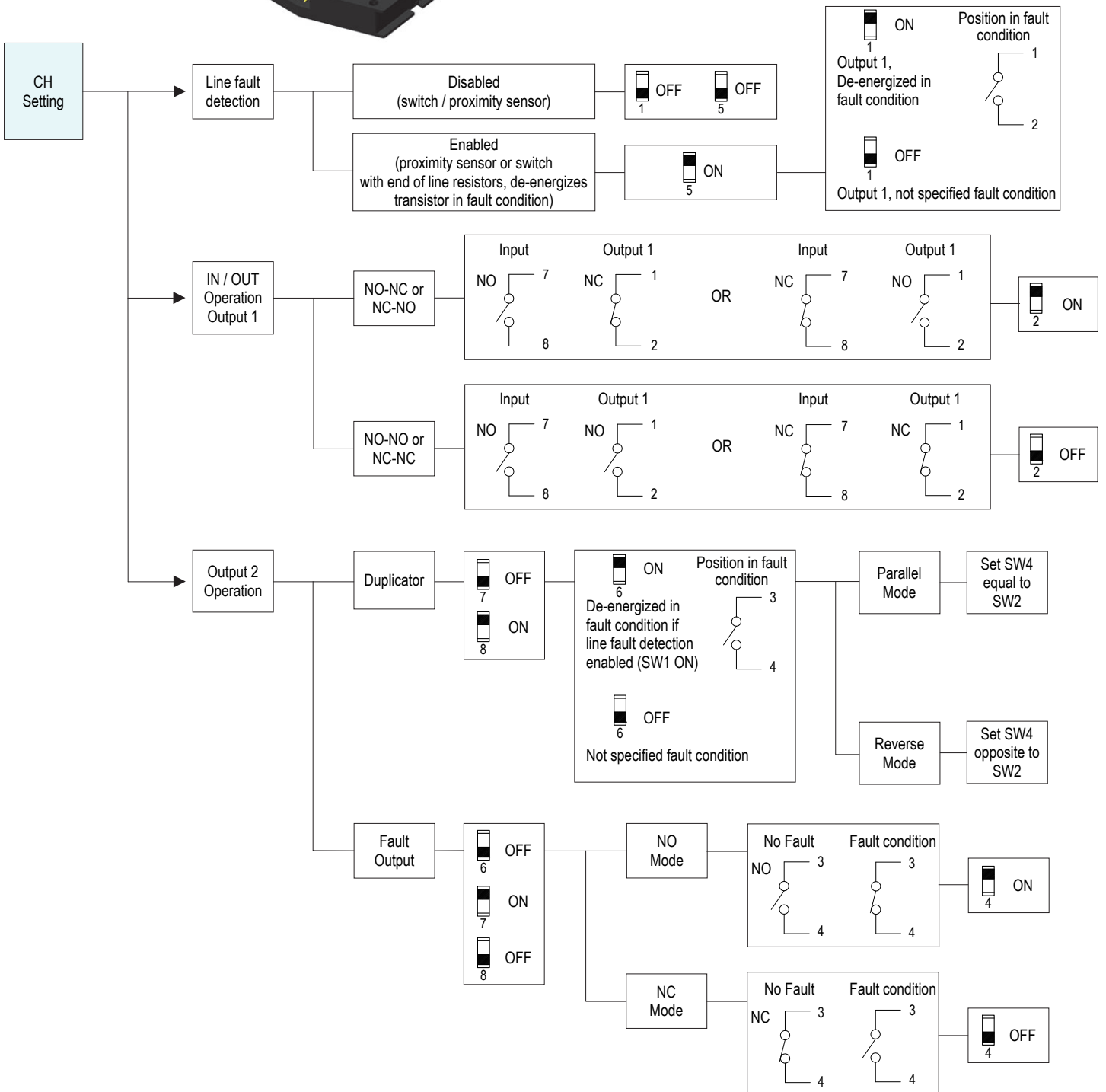

D6031S

A configuration DIP switch is located on component side of pcb. This switch allows the configuration of input/output relationship, fault detection functions and operating mode.

WARNING: Dip-switch 7-8 must be set to "OFF" position.

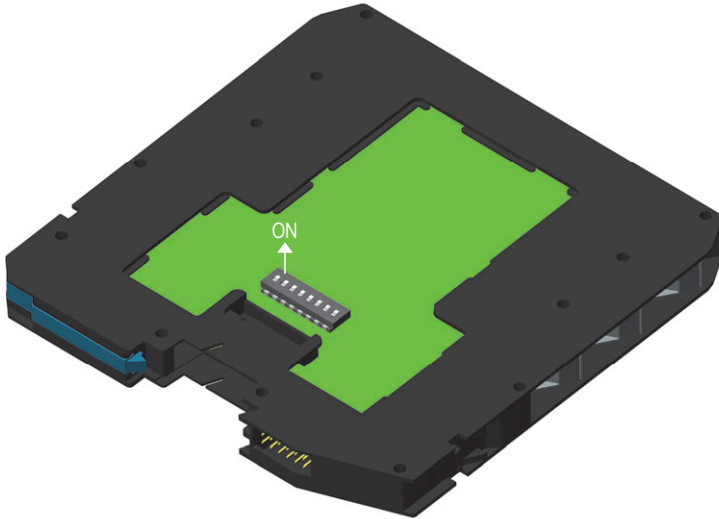

Dip switch factory settings. All Switches are OFF

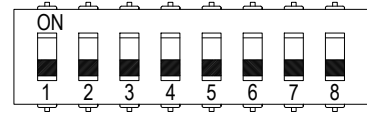

Dip switch configuration

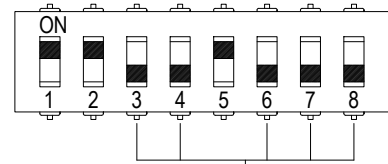

7-8 must be set to "OFF" position
3-4-6 Not used

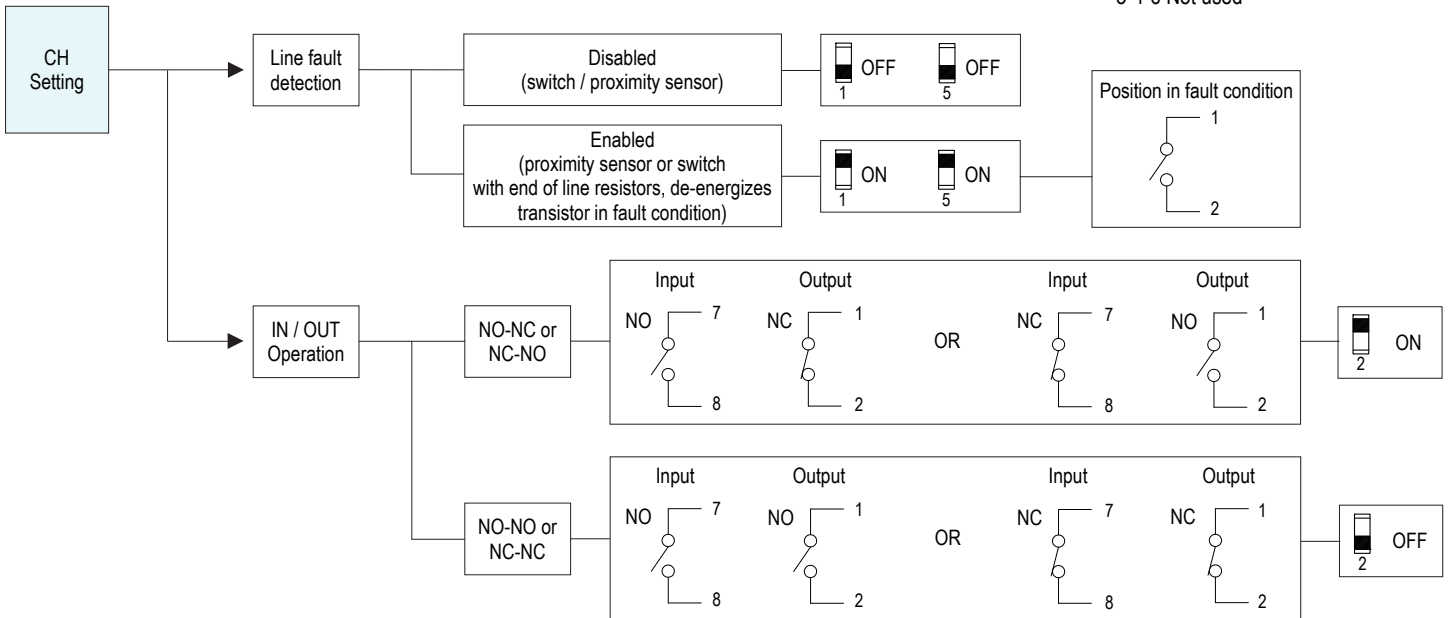

DIP Switch factory settings (valid for D6031S and D6031D)

SW1	SW2	SW3	SW4	SW5	SW6	SW7	SW8
OFF	OFF	OFF	OFF	OFF	OFF	OFF	OFF

D6031D (used as double channel) Configuration Summary Table

WARNING: dip-switch 6-7-8 must be set to “OFF” position.

Channel	1		2
Line fault detection	SW1	SW5	SW3
Disabled (switch/proximity sensor)	OFF	OFF	OFF
Enabled (proximity sensor or switch with end of line resistors, detects field open circuit and short circuit, de-energizes transistor in fault condition)	ON	ON	ON

Channel	1	2
IN/OUT Operation	SW2	SW4
NO-NC or NC-NO	ON	ON
NO-NO or NC-NC	OFF	OFF

D6031D (used as duplicator or fault output) Configuration Summary Table

WARNING: Terminals 9-10 must be shorted to set module as Duplicator or Fault Out. Dip-switch 3 must be set to “OFF” position.

Line fault detection	SW1		SW5
Disabled (switch/proximity sensor)	OFF		OFF
Enabled (proximity sensor or switch with end of line resistors, detects field open circuit and short circuit, de-energizes relay in fault condition)	Output 1, De-energized in Fault condition	ON	ON
	Output 1, Not specified Fault condition	OFF	

IN/OUT Operation Output 1	SW2
NO-NC or NC-NO	ON
NO-NO or NC-NC	OFF

Output 2 Operation	SW6		SW7	SW8	Mode	SW4
Duplicator	De-energized in fault condition if line fault detection enabled (SW1 ON)	ON	OFF	ON	Parallel	Set equal to SW2
	Not specified Fault condition	OFF			Reverse	Set opposite to SW2
Fault Output	OFF		ON	OFF	NO	ON
					NC	OFF

D6031S Configuration Summary Table

WARNING: Dip-switch 7-8 must be set to “OFF” position.

Line fault detection	SW1	SW5
Disabled (switch/proximity sensor)	OFF	OFF
Enabled (proximity sensor or switch with end of line resistors, detects field open circuit and short circuit, de-energizes relay in fault condition)	ON	ON

IN/OUT Operation	SW2
NO-NC or NC-NO	ON
NO-NO or NC-NC	OFF